

KOMATSU

D85EX-18

D85PX-18

EU Stage V Engine

CRAWLER DOZER

D
85



ENGINE POWER

199 kW / 267 HP @ 1.900 rpm

OPERATING WEIGHT

D85EX-18: 27.900 kg
D85PX-18: 28.770 kg

BLADE CAPACITY

5,90 - 7,20 m³

Walk-Around

D85EX8/PX-18



ENGINE POWER

199 kW / 267 HP @ 1.900 rpm

OPERATING WEIGHT

D85EX-18: 27.900 kg
D85PX-18: 28.770 kg

BLADE CAPACITY

5,90 - 7,20 m³



INCREASED PRODUCTIVITY & OUTSTANDING FUEL ECONOMY

Powerful and Environmentally Friendly

- Low consumption EU Stage V engine
- Powerful torque converter drive with automatic gear shifting
- Adjustable auto idle shutdown
- Hydrostatic cooling fan with cleaning mode

Optimised Work Equipment

- Sigmadozer® blade with hydraulic pitch
- Straight tilt & Semi-U tilt dozer blades
- Multishank parallelogram ripper

First-Class Operator Comfort

- Quiet and comfortable cab
- Fully adjustable air-suspended seat
- Integrated rear-view camera

State-of-the-Art Controls

- Hydrostatic steering system
- Gearshift preset function
- Palm Command Control System (PCCS)
- Large multifunctional monitor with troubleshooting function

Tough and Reliable

- Low drive undercarriage
- Sturdy, rugged design
- Self-adjusting idler support
- Extra long life “PLUS” undercarriage (option)

KOMTRAX

- Komatsu Wireless Monitoring System
- 3G mobile communications
- Integrated communication antenna
- Increased operational data and fuel savings



A maintenance program
for Komatsu customers

Powerful and Environmentally Friendly



Automatic transmission

Set by default, the D85-18 has a highly efficient transmission that automatically matches the best gear mode in all dozing operations and includes a travel speed preset function to reduce work time and fatigue for the operator. With Komatsu's ECMV (Electronic Controlled Modulation Valves) gear changes are smoothly timed to always keep the power transfer at maximum efficiency.

Efficient hydrostatic engine cooling fan

The cooling fan always runs at the lowest convenient speed. Rotation and velocity are electronically adjusted based on the temperature of the engine coolant and hydraulic oil. This reduces fuel consumption and operating noise levels, and requires less horsepower than a belt-driven fan.

Adjustable idle shutdown

To reduce unnecessary fuel consumption and exhaust emissions, and for lower operating costs, the Komatsu auto idle shutdown automatically turns off the engine after it idles for a set period of time, which can be easily programmed from 5 to 60 minutes. An Eco-gauge and Eco guidance tips on the cab monitor further encourage efficient operations.

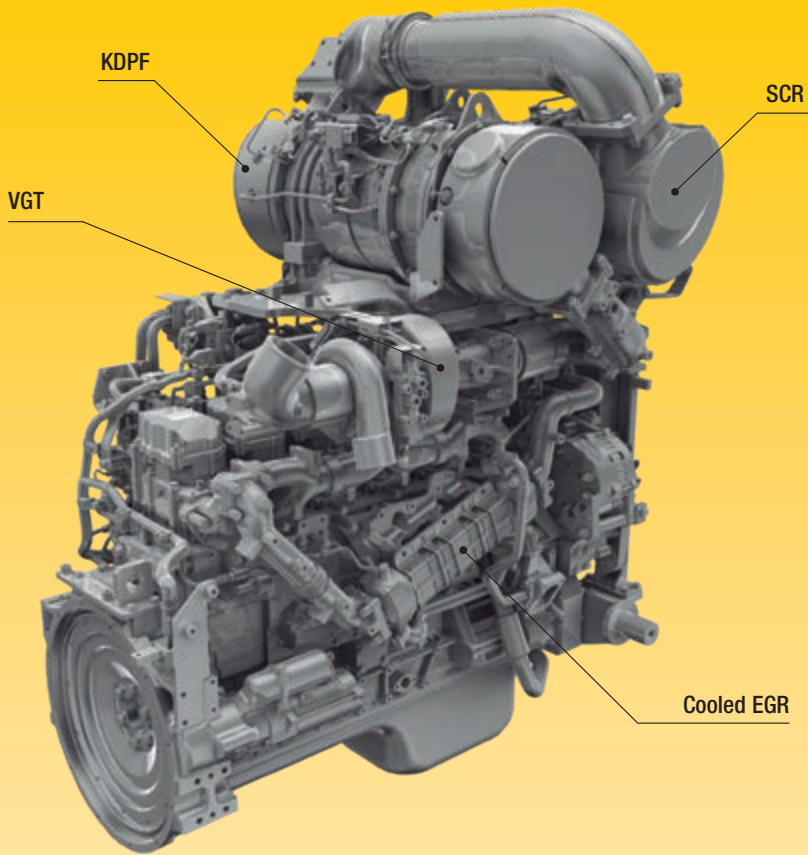
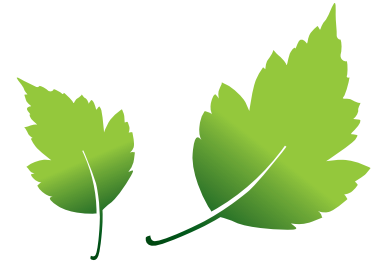

Komatsu EU Stage V

The Komatsu EU Stage V engine is productive, dependable and efficient. With ultra-low emissions, it provides a lesser environmental impact and a superior performance to help reduce operating costs and lets the operator work in complete peace of mind.

Heavy-duty aftertreatment

The aftertreatment system combines a Komatsu Diesel Particulate Filter (KDPF) and Selective Catalytic Reduction (SCR). The SCR system injects the correct amount of AdBlue® at the proper rate to break down NOx into water (H₂O) and nontoxic nitrogen gas (N₂). NOx emissions are reduced by 80% vs. EU Stage IIIB engines.

Exhaust Gas Recirculation (EGR)

Cooled EGR is a technology well-proven in current Komatsu engines. The increased capacity of the EGR cooler now ensures very low NOx emissions and a better engine performance.

Komatsu Closed Crankcase Ventilation (KCCV)

Crankcase emissions (blow-by gas) are passed through a CCV filter. The oil mist trapped in the filter is returned back to the crankcase while the filtered gas is returned to the air intake.

High-Pressure Common Rail (HPCR)

To achieve complete fuel burn and lower exhaust emissions, the heavy-duty High-Pressure Common Rail fuel injection system is computer controlled to deliver a precise quantity of pressurised fuel into the redesigned engine combustion chamber by multiple injections.

Variable Geometry Turbo (VGT)

The VGT provides optimal airflow to the engine combustion chamber under all speed and load conditions. Exhaust gas is cleaner, fuel economy is improved while machine power and performance are maintained.

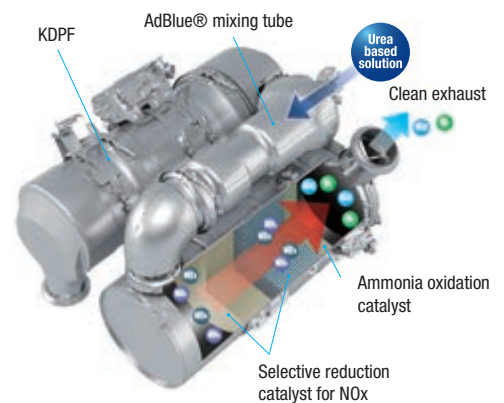

Automatic gearshift mode to further reduce fuel consumption



Eco-gauge, Eco guidance and fuel consumption gauge



Fuel consumption history

Optimised Work Equipment

Komatsu blades

For increased blade performance and better machine balance, Komatsu uses a box blade design, with the highest resistance for a light weight blade. Special Komatsu highly wear resistant steel is used for the front and sides of the blade to increase durability. The deep curved design of the blade makes it easy to handle a wide range of materials, with good penetration and a large capacity, optimising high dozing performance with excellent fuel efficiency.

Multishank parallelogram ripper (option)

The multishank parallelogram ripper has 3 ripper shanks as standard, but can be easily converted to a giant or two-shank ripper, depending on job conditions. The strong parallelogram design offers straight shank movement, adapted for tough applications.

Sigadozer® blade (EX)

The middle section of Komatsu's Sigadozer® blade acts like a V-shaped bucket with aggressive ground penetration. Its lateral blade edges help to push the rolling material continuously towards the centre. Combined with the blade's deep curve, this largely increases effective capacity and reduces spillage and fuel consumption. The blade's flat cutting edge and the standard pitch function also offer top grading performance. Overall, the Sigadozer® blade increases dozing productivity by more than 15% compared to a conventional Semi-U blade.

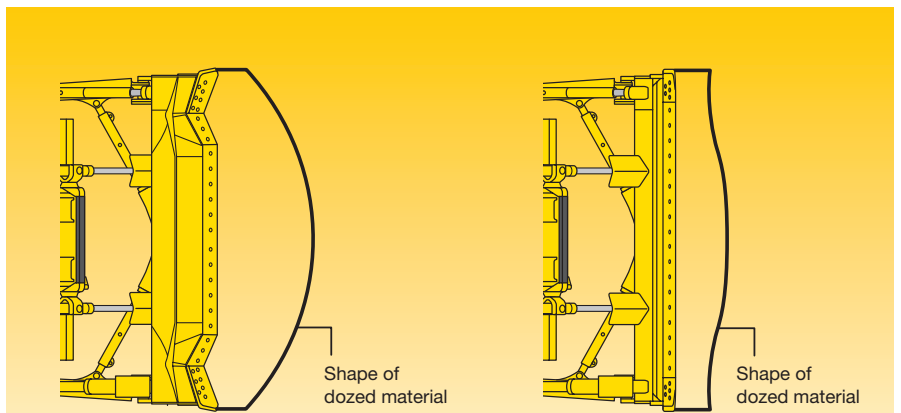

Up to 15% higher productivity with the improved Sigadozer® blade (left), compared to conventional Semi-U blade (right)



The Sigadozer® blade offers highest material holding capacity



Semi-U blade



First-Class Comfort

Quiet and comfortable cab

Operator comfort is essential for safe and productive work. The cab on the D85-18 is quiet and comfortable, an ideal environment to concentrate on the job. Its hexagonal design and large tinted glass windows offer excellent panoramic visibility. The high capacity and fully automatic climate control system pressurises the cab to keep dust out. A high quality sound-absorbent lining covers the interior to minimise noise levels for the operator.

Fully adjustable suspension seat and travel-control console

A comfortable, heavy-duty and fully adjustable heated air-suspended seat is at the centre of the operator's safe and cosy work space. For dozing operations, the seat faces straight forward, with a perfect view of both sides of the blade. For ripping, it can be turned 15° to the right to significantly improve rear visibility and reduce neck strain. The position of the travel control console can also be independently adjusted forwards, backwards and in height to fit each operator's preference.

Superior visibility on blade and ripper

The redesigned ROPS/FOPS integrated cab and the well-located operator seat give optimal blade visibility to the left and right and make both dozing and grading easy, safe and fast. To further improve safety and ripping efficiency, the special shape of the fuel tank gives the operator a clear view of the ripper point and of the dozer's back side.



D85EX8/PX-18

State-of-the-Art Controls



Hydrostatic steering system

The hydrostatic steering system (HSS) offers fast response and more precise turning. Both tracks are powered without interruption allowing smooth, continuous turns and powerful and productive dozing even on soft ground or on slopes.

Gearshift preset function

To reduce the frequency of gear shifting and for comfortable machine operation, a shift preset mode is provided as standard equipment. The preset switch lets the operator select a combination of forward/reverse gear shifts by using the UP/DOWN shift switch on the steering lever. Once the shift pattern is selected, only forward/reverse direction control selection is required for a correct gear shift.

Easy and precise

The ergonomic Palm Command Control System (PCCS) provides efficient and comfortable steering. The new control levers are fingertip controlled for precise and fatigue-free operating. When backing up over shot rock or other rough surfaces, travel speed can be reduced with the "slow reverse" function to improve ride quality and decrease vibrations and fuel consumption.

Selectable working modes

Working mode can be set to either "Power" for maximum power or to "Economy" for energy saving operations. Combined with a choice between automatic or manual working mode, this lets the operator select the optimum machine power configuration for the work at hand.



Palm Command Control System (PCCS)



Remote safety lock levers



Fully integrated rear-view camera system



Lower operating costs

Komatsu ICT contributes to the reduction of operating costs by assisting to comfortably and efficiently manage operations. It raises the level of customer satisfaction and the competitive edge of our products.

Widescreen monitor

Conveniently customisable and with a choice of 26 languages, the wide-screen monitor with simple switches and multifunction keys gives fingertip access to a large range of functions and operating info. An AdBlue® level gauge is now incorporated into the default main screen.

An evolutionary interface

Helpful information is now easier than ever to find and understand with the upgraded monitor interface. The main screen can be simply optimised to the operator's preference by just pressing one button.



Quick view on the operation logs



All information at a glance

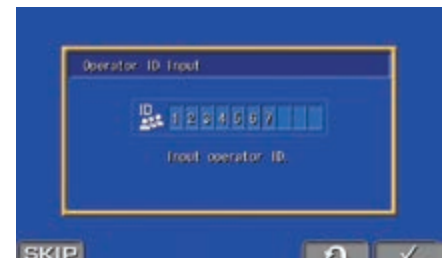

Operator identification function

KOMTRAX

The way to higher productivity

KOMTRAX uses the latest wireless monitoring technology. Compatible on PC, smartphone or tablet, it delivers insightful and cost saving information about your fleet and equipment, and offers a wealth of information to facilitate peak machine performance. By creating a tightly integrated web of support it allows proactive and preventive maintenance and helps to efficiently run a business.



Knowledge

You get quick answers to basic and critical questions about your machines – what they're doing, when they did it, where they're located, how they can be used more efficiently and when they need to be serviced. Performance data is relayed by wireless communication technology (Satellite, GPRS or 3G depending on model) from the machine to a computer and to the local Komatsu distributor – who's readily available for expert analysis and feedback.

Power

The detailed information that KOMTRAX puts at your fingertips 24 hours a day, 7 days a week gives the power to make better daily and long-term strategic decisions – at no extra cost. Problems can be anticipated, maintenance schedules customised, downtime minimised and machines kept where they belong: working on the jobsite.

Convenience

KOMTRAX enables convenient fleet management on the web, wherever you are. Data is analysed and packaged specifically for effortless and intuitive viewing in maps, lists, graphs and charts. You can foresee eventual maintenance issues and required spare parts, and troubleshoot a problem before Komatsu technicians arrive on site.



Easy Maintenance



Komatsu CARE™

Komatsu CARE™ is a maintenance program that comes as standard with your new Komatsu machine. It covers factory-scheduled maintenance, performed with Komatsu Genuine parts by Komatsu-trained technicians. Depending on your machine's engine, it also offers extended coverage of the Komatsu Diesel Particulate Filter (KDPF) or the Komatsu Diesel Oxidation Catalyst (KDOC), and of the Selective Catalytic Reduction (SCR). Please contact your local Komatsu distributor for terms and conditions.

Central service points

Komatsu designed the D85-18 with centralised and conveniently located service points to make necessary inspections and maintenance quick and easy.

Modular power train

All the power train components are enclosed in a sealed module. This eliminates oil spills during mounting and dismounting, and prevents dust and dirt polluting individual components. Servicing is much cleaner, smoother and easier.

The multifunction monitor panel displays the running time, engine revs, fuel level and water coolant temperature in real time. It also provides the operator with maintenance and service information, if oil filters need replacing or any abnormality occurs. In addition, it supplies Komatsu mechanics with detailed information, with no need for external service tools.

Reversible radiator fan

The radiator can be easily cleaned by utilisation of the reversible, hydraulically driven cooling fan from a touch on the monitor panel. This cleaning reduces fuel consumption and increases overall machine performance.



Tough and Reliable

Sturdy, rugged design

A high-rigidity hull structure main frame improves durability and reduces stress concentration at critical areas. The track frame with a large cross section utilises pivot shaft mounting for greater reliability. All hydraulic piping is robustly protected by cover and inner route to ensure damage protection from materials.

Protected hydraulic piping

Komatsu has designed the hydraulics of the working equipment so it minimises maintenance costs. All the hydraulic lines are well protected with special linings and embedded into the steel structures whenever possible.

Low-drive "PLUS" undercarriage (option)

Komatsu's low-drive Parallel Link Undercarriage System (PLUS) is extraordinarily tough, with excellent grading performance and stability. It features PLUS link assemblies, a highly reliable floating bushing concept, substantial track link height, superior oil seals and track guards that maximise undercarriage durability. For easier servicing, the equaliser bar's centre pin is remotely greased. The segmented sprockets are notched to considerably improve the evacuation of mud and further increase the PLUS undercarriage lifetime.

Highly reliable electric circuit

The new generation of Komatsu dozers have special reinforced electrical wiring harnesses covered with a heat-resistant material that improves mechanical strength, provides longer life, and protects the system from damage. The reliability of the D85-18's electrical circuit is further increased by the use of "DT connectors" that have a very high resistance to dust, corrosion and moisture and keep your machine up and running.

Self-adjusting idler support

The self-adjusting idler support provides constant and even tension on idler guide plates. It reduces noise levels and vibrations and increases undercarriage life.



Hydraulic lines are embedded into the structures whenever possible



Self-adjusting idler support



Specifications

ENGINE

Model	Komatsu SAA6D125E-7
Type	Common rail direct injection, water-cooled, emissionised, turbocharged, after-cooled diesel
Engine power	
at rated engine speed	1.900 rpm
ISO 14396	199 kW/267 HP
ISO 9249 (net engine power)	197 kW/264 HP
No. of cylinders	6
Bore × stroke	125 × 150 mm
Displacement	11,04 l
Fan drive type	Hydraulic, reversible
Lubrication system	
Method	Gear pump, force lubrication
Filter	Full flow
Fuel	Diesel fuel, conforming to EN590 Class 2/Grade D. Paraffinic fuel capability (HVO, GTL, BTL), conforming to EN 15940:2016

TORQFLOW TRANSMISSION

Type	Komatsu TORQFLOW
Torque converter	3-element, 1-stage, 1-phase
Transmission	Planetary gear, multiple-disc clutch hydraulically actuated, force-lubricated
Gearshift lock lever and neutral safety switch prevent accidental starts	

MAX. TRAVEL SPEEDS (EX/PX)

	Forward	Reverse
1st	3,3 / 3,3 km/h	4,4 / 4,4 km/h
2nd	6,1 / 6,0 km/h	8,0 / 7,9 km/h
3rd L	7,8 / 7,8 km/h	9,2 / 9,2 km/h
3rd	10,1 / 10,0 km/h	13,0 / 12,7 km/h

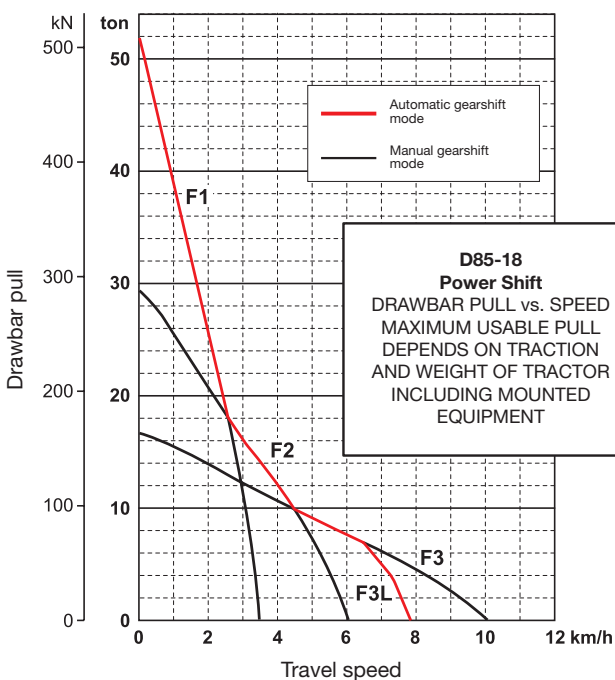

STEERING SYSTEM

Type	Hydrostatic Steering System (HSS)
Steering control	PCCS-lever
Service brakes	Wet, multiple-disc, pedal-controlled, spring-actuated and hydraulically released
Minimum turning radius (counter-rotation) as measured by track marks on ground	
D85EX-18	1,99 m
D85PX-18	2,24 m

OPERATING WEIGHT (APPR.)

Including blade, ROPS cab, hydraulic control unit, operator, standard equipment, rated capacity of lubricant, coolant, and full fuel tank

D85EX-18 with Sigmadozer®	27.900 kg
D85EX-18 with Semi-U blade	27.650 kg
D85PX-18 with Straight tilt blade	28.770 kg

ENVIRONMENT

Engine emissions	Fully complies with EU Stage V exhaust emission regulations
Noise levels	
LwA external	111 dB(A) (2000/14/EC Stage I)
LpA operator ear	79 dB(A) (ISO 6396 dynamic test)
Vibration levels (EN 12096:1997)	
Hand/arm	≤ 2,5 m/s ² (uncertainty K = 0,73 m/s ²)
Body	≤ 0,5 m/s ² (uncertainty K = 0,25 m/s ²)
Contains fluorinated greenhouse gas HFC-134a (GWP 1430). Quantity of gas 0,9 kg, CO ₂ equivalent 1,29 t	

SERVICE REFILL CAPACITIES

Fuel tank	470 l
Radiator	69 l
Engine oil	38 l
Torque converter, transmission, bevel gear and steering system	60 l
Final drive (each side)	
D85EX-18	26 l
D85PX-18	36 l
Work equipment hydraulics	69 l
Multishank ripper	20 l
AdBlue® tank	34,6 l

FINAL DRIVE

Type	Spur and planetary gear, double-reduction
Sprocket	Segmented sprocket teeth are bolt-on for easy replacement

MULTISHANK RIPPER (EX)

Type	Hydraulically controlled parallelogram ripper
No. of shanks	3
Weight (including hydraulic control unit)	2.500 kg
Max. digging depth	655 mm

D85EX8/PX-18

UNDERCARRIAGE

Suspension	Oscillating equaliser bar and pivot shaft
Track roller frame	Monocoque, large section, durable construction
Rollers and idlers	Lubricated track rollers
Track tension	Combined spring and hydraulic unit

TRACKS

	D85EX-18	D85PX-18
Number of track rollers (each side)	7	8
Number of shoes (each side)	41	45
Shoe width (standard)	610 mm	910 mm
Ground contact area (ISO16754)	42.206 cm ²	71.012 cm ²
Ground pressure (ISO16754)*	0,66 kg/cm ²	0,41 kg/cm ²
Track gauge	2.000 mm	2.250 mm
Length of track on ground	3.050 mm	3.480 mm

* Including blade, ROPS cab, hydraulic control unit, operator, standard equipment, rated capacity of lubricant, coolant, and full fuel tank.

HYDRAULIC SYSTEM

Type	CLSS (closed-centre load sensing system)
All spool valves externally mounted beside the hydraulic tank	
Main pump	Variable displacement piston pump
Maximum pump flow	331 l/min
Relief valve setting	230 kg/cm ²

NUMBER OF CYLINDERS × BORE

Type of blade	Sigmaxdozer®	Straight tilt Semi-U
Blade lift	2 × 100 mm	2 × 100 mm
Blade tilt	1 × 150 mm	1 × 150 mm
Blade pitch	1 × 150 mm	–
Ripper lift	2 × 130 mm	2 × 130 mm

DIMENSIONS

	D85EX-18 Sigmaxdozer® with multishank ripper	D85EX-18 Semi-U blade with multishank ripper	D85PX-18 Straight tilt blade with long drawbar
A	5.810 mm	5.820 mm	6.025 mm
B	2.000 mm	2.000 mm	2.250 mm
C	3.322 mm	3.322 mm	3.322 mm
D	3.290 mm	3.290 mm	3.290 mm
E	3.050 mm	3.050 mm	3.480 mm
F	1.515 mm	1.515 mm	410 mm (Long drawbar)
G	610 mm	610 mm	910 mm
H	72 mm	72 mm	72 mm

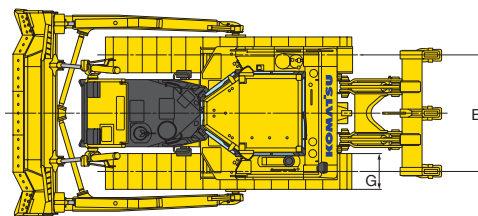
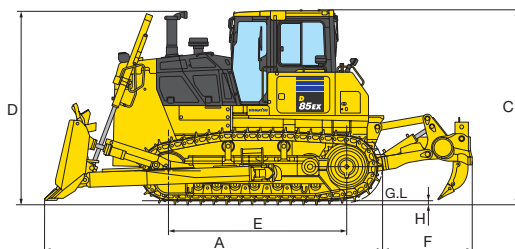

Ground clearance: 450 mm (+ grouser height)

DOZER EQUIPMENT

	Overall length with blade	Blade capacity	Blade width × height	Max. lift above ground	Max. drop below ground	Max. tilt adjustment	Assembly weight
D85EX-18 Strengthened Sigmaxdozer®	5.810 mm	7,2 m ³	3.575 × 1.665 mm*	1.215 mm	590 mm	700 mm	4.030 kg
D85EX-18 Strengthened Semi-U tilt	5.820 mm	7,0 m ³	3.635 × 1.605 mm	1.175 mm	530 mm	735 mm	3.780 kg
D85PX-18 Straight tilt	6.025 mm	5,9 m ³	4.355 × 1.400 mm	1.230 mm	560 mm	500 mm	3.140 kg

Blade capacities are based on the SAE recommended practice J1265.

* Including spill guard.

Standard and Optional Equipment

ENGINE AND RELATED PARTS

Komatsu SAA6D125E-7 turbocharged common rail direct injection diesel engine	●
EU Stage V compliant	●
Starter motor 24 V/7,5 kW	●
Alternator 24 V/90 A	●
Batteries 2 × 12 V/200 Ah	●
Exhaust pipe with rain cap	●
Cooling fan, hydrostatic driven with reversing function	●
Radiator reserve tank	●
Heavy-duty radiator mask	●
Fuel tank inlet strainer	●
Fuel pre-filter (10 micron) and fuel filter (2 micron)	●
Locks, filter caps and covers	●
Gull wing engine side covers	●
Cyclone type air pre-cleaner	○
Starter motor 24 V/11 kW	○

TRANSMISSION AND BRAKES

Automatic hydroshift transmission	●
Torque converter	●
Damper	●
Quick shift selection system	●
HSS hydrostatic steering system	●
Palm lever steering control (PCCS)	●
Decelerator pedal	●
Brake pedal	●

SERVICE AND MAINTENANCE

Dry type air cleaner, double element with dust indicator and evacuator	●
Multifunction video compatible colour monitor with Equipment Management and Monitoring System (EMMS) and efficiency guidance	●
Water separator	●
KOMTRAX – Komatsu wireless monitoring system (3G)	●
Komatsu CARE™ – a maintenance program for Komatsu customers	●
Tool kit	●
Grease gun holder	●

CABIN

Heated air-suspended seat: fabric, reclining, high backrest, turnable	●
High mount footrest	●
Automatic air conditioner	●
Radio with Bluetooth®	●
Auxiliary input (MP3 jack)	●
USB port for charging	●
2 × 12 Volt power supply (120 W)	●
1 × 24 Volt power supply	●
Viscous cab mounts	●
Wiper front and rear window	●
Wipers doors	●
Rear-view mirror (inside cab)	●
Front window sun roller blind	●
Cup holder	●

SAFETY EQUIPMENT

Steel cab, meets ISO 3471 and SAE J1040, APR88 ROPS standards, as well as ISO 3449 FOPS standards	●
Back-up alarm	●
Warning horn	●
Rear-view camera system	●
Locks, filter caps and covers	●
Battery main switch (lockable)	●
Secondary engine shutdown switch	●
Seat belt caution indicator	●
Tie-off points	●
Handrails	●

ATTACHMENTS

Front pull hook	●
Rigid drawbar	●
Rear counterweight with hitch	○
Multishank parallelogram ripper	○

LIGHTING SYSTEM

Working lights: 4 front and 2 rear lights	●
Additional working light, rear	●
Ripper working light	○

HYDRAULIC SYSTEM

Hydraulics for dozing blades	●
Mono lever blade control	●
Hydraulics for ripper	●

UNDERCARRIAGE

Single grouser shoes: (EX): 610 mm (PX): 910 mm	●
Track roller guard, centre and end sections	●
Segmented sprockets	●
Fixed track rollers	●
Hydraulic track adjusters	●
Underguards, oil pan and transmission	●
Full length track roller guard	○
Single grouser shoes (EX): 560 mm, 660 mm	○
Single grouser heavy-duty shoes (EX): 560 mm, 610 mm, 660 mm	○
Heavy-duty PLUS undercarriage	○

DOZER EQUIPMENT

Sigmadazer® blade, with pitch function, single tilt 7,2 m³ (EX)	●
Straight tilt blade 5,9 m³ (PX)	●
Semi-U blade 7,0 m³ (EX)	○

Further equipment on request

- standard equipment
- optional equipment

Your Komatsu partner:

KOMATSU

**Komatsu Europe
International N.V.**

Mechelsesteenweg 586
B-1800 VILVOORDE (BELGIUM)
Tel. +32-2-255 24 11
Fax +32-2-252 19 81
www.komatsu.eu

EENSS20127 07/2025

KOMATSU is a trademark of Komatsu Ltd. Japan.

D85EX8/PX-18