

# KOMATSU

## PC230NHD-11



Hydraulic excavator

**Engine power**  
123 kW / 165 HP @ 2000 rpm

**Operating weight**  
23515 - 24315 kg

**Bucket capacity**  
max. 1.45 m<sup>3</sup>

## PC230NHD-11



Engine power  
**123 kW / 165 HP @ 2000 rpm**

Operating weight  
**23515 - 24315 kg**

Bucket capacity  
**max. 1.45 m<sup>3</sup>**

# Exceptional workability and environmental performance

## Powerful and environmentally friendly

- EU Stage V engine
- Adjustable idle shutdown
- Komatsu fuel-saving technology

## Narrow heavy duty design

- Narrow heavy duty undercarriage
- Narrow upper structure
- Transport width only 2540 mm
- Easy transportation without special permits



## Maximised efficiency

- Increased productivity
- Built-in versatility and superior productivity
- Enhanced engine management
- Improved hydraulic efficiency
- Komatsu Integrated Attachment Control (KIAC)

## First-class comfort

- Fully air-suspended operator station
- Low-noise design
- Widescreen monitor

## Safety first

- Komatsu SpaceCab™
- KomVision surround view system
- Neutral position detection system

## Quality you can rely on

- Komatsu-quality components
- Extensive dealer support network

## Komtrax

- Komatsu Wireless Monitoring System
- 4G mobile communications
- Integrated communication antenna
- Increased operational data and reports



A maintenance program  
for Komatsu customers

## PC230NHD-11



### Higher productivity

The PC230NHD-11 is quick and precise. It features a powerful Komatsu EU Stage V engine, Komatsu's Closed Center Load Sensing (CLSS) hydraulic system and first-class Komatsu comfort to provide a fast response and unrivalled productivity for its class.

### Komatsu fuel-saving technology

Fuel consumption on the PC230NHD-11 is lower by up to 15% (compared to PC230NHD-8). Engine management is enhanced. The variable speed matching of the engine and hydraulic pump and a viscous fan clutch guarantee efficiency and precision during single and combined movements.

### Adjustable idle shutdown

The Komatsu auto idle shutdown automatically turns off the engine after it idles for a set period of time. This feature can easily be programmed from 5 to 60 minutes, to reduce unnecessary fuel consumption and exhaust emissions, and to lower operating costs. An Eco-gauge and the Eco guidance tips on the cab monitor further encourage efficient operations.

## Powerful and environmentally friendly

### Komatsu EU Stage V

The Komatsu EU Stage V engine is productive, dependable and efficient. With ultra-low emissions, it provides a lower environmental impact and a superior performance to help reduce operating costs and lets the operator work in complete peace of mind.

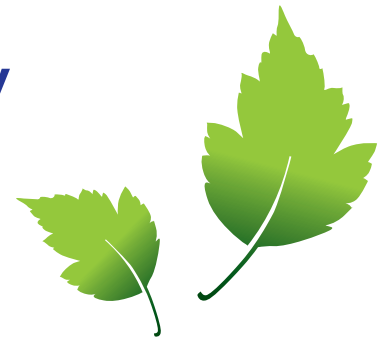

### Heavy-duty aftertreatment

The aftertreatment system combines a Komatsu Diesel Particulate Filter (KDPF) and Selective Catalytic Reduction (SCR). The SCR injects the correct amount of AdBlue® into the system at the proper rate to break down NOx into water (H<sub>2</sub>O) and non-toxic nitrogen gas (N<sub>2</sub>). NOx emissions are reduced by 80% vs. EU Stage IIIB engines.

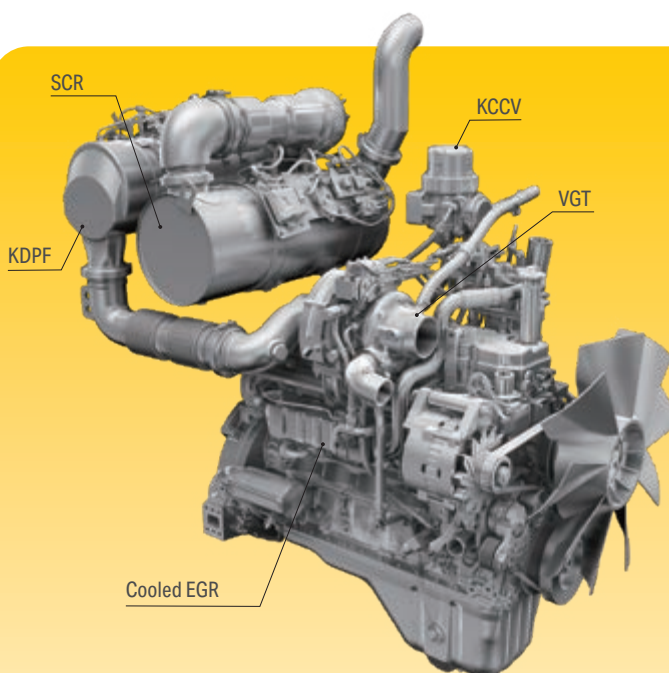
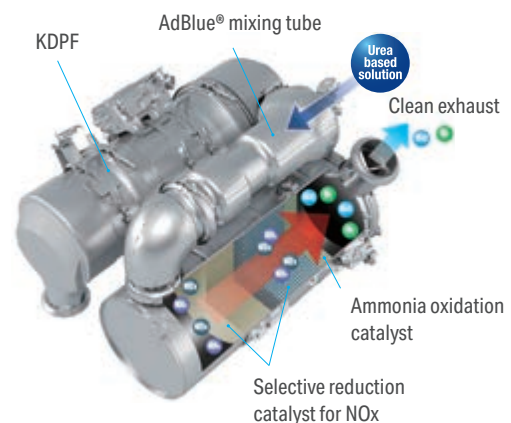

#### High-Pressure Common Rail (HPCR)

To achieve complete fuel burn and lower exhaust emissions, the heavy-duty High-Pressure Common Rail fuel injection system is computer controlled to deliver a precise quantity of pressurised fuel into the redesigned engine combustion chamber by multiple injections.

#### Exhaust Gas Recirculation (EGR)

Cooled EGR is a technology well-proven in current Komatsu engines. The increased capacity of the EGR cooler now ensures very low NOx emissions and a better engine performance.

#### Komatsu Closed Crankcase Ventilation (KCCV)

Crankcase emissions (blow-by gas) are passed through a CCV filter. The oil mist trapped in the filter is returned back to the crankcase while the filtered gas is returned to the air intake.

#### Variable Geometry Turbo (VGT)

The VGT provides optimal airflow to the engine combustion chamber under all speed and load conditions. Exhaust gas is cleaner, fuel economy is improved while machine power and performance are maintained.

# PC230NHD-11

## A wide choice of options

Two optional attachment lines are available and 15 attachment memory settings are simply customised. Combined with a standard-fit hydraulic quick coupler power circuit, it's easier than ever to switch working styles. With a choice of arms you can configure the PC230NHD-11 to match specific demands for transport, working envelope or duty.

## 6 working modes

The PC230NHD-11 delivers the power required with the lowest fuel usage. 6 working modes are available: Power, Lifting/Fine Operation, Breaker, Economy, Attachment Power and Attachment Economy. The operator can ideally balance the Economy mode between power and economy to match the work at hand. The oil flow delivered to hydraulic attachments is also adjustable directly on the class-leading widescreen monitor panel.



Narrow heavy duty undercarriage and narrow upper structure



Two optional hydraulic lines to mount a variety of attachments

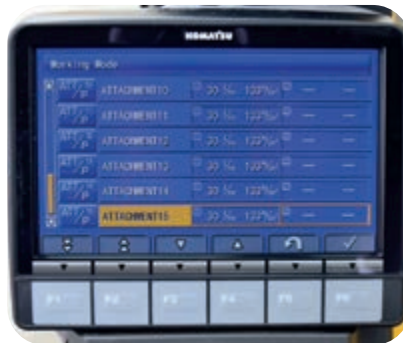

Komatsu Integrated Attachment Control (KIAC) for up to 15 tool presets for oil flow and pressure



Versatility at your fingertips: select the perfect setting for each job



## Maximised efficiency

### **Bigger, heavier and sturdy undercarriage structure**

The PC230NHD-11 has a bigger and heavier undercarriage than the PC210NLC, specifically designed for jobs in severe duty ground conditions. It has a narrow gauge (shipping width 2.5 m) for easy transport, and is intended for mountain and other areas requiring an extra strong undercarriage.



## First-class comfort

### Enhanced work environment

Designed to prioritise both productivity and operator well-being, the Komatsu crawler excavator cab features thoughtful ergonomics with high-visibility handrails, and improved interior LED lighting. Stepping inside reveals a sleek, dark colour scheme complemented by an effortlessly cleanable floor mat. Upgraded UV-protective tint on the cab rear window minimises sun exposure and helps maintain a cool working environment.

### Future-proof customisable workspace

The operator cab offers extensive customisation possibilities. A multi-functional utility bar allows for adding personal accessories such as additional monitors or tablets, while dual USB ports (USB-A & USB-C) enable mobile device charging.



Convenient and secure entry to the spacious, well-insulated, low-noise cab



Multi-functional utility bar (items shown are for illustrative purposes only)



Optional premium seat with top quality cushioning, auto weight adjustment, lumbar support, climate control system, available with optional multi-position armrests and ergonomic control levers



## Safety first

### Optimal jobsite safety

Safety features on the Komatsu PC230NHD-11 comply with the latest industry standards and work in synergy to minimise risks to people in and around the machine. A neutral detection system for travel and work equipment levers increase jobsite safety, along with a seat belt caution indicator and an audible travel alarm. Highly durable anti-slip plates – with additional high friction covering – maintain long term traction performance.



### Safe maintenance

Thermal guards around high temperature areas of the engine, protected fan belt and pulleys, a pump/engine partition that prevents hydraulic oil from spraying onto the engine, a wide catwalk and exceptionally sturdy handrails: in Komatsu tradition, the highest safety level is provided for a fast and smooth maintenance.



### Komatsu SpaceCab™

The ROPS cab has a tubular steel frame and provides high shock absorbercy, impact resistance and durability. The seat belt is well designed to keep the operator in the safety zone of the cab in the event of a rollover. Optionally the cab can be fitted with a Falling Object Protective System (FOPS) with openable front guard.



### KomVision

KomVision machine visibility gives the operator a constant clear view of the safety zone around the machine. This allows the operator to focus on the work at hand even in low light conditions.



## An evolutionary interface

Helpful information is now easier than ever to find and understand with the upgraded monitor interface. An optimal main screen for the ongoing work can be selected simply by pressing the F3 key.

## Lower operating costs

Komatsu ICT contributes to the reduction of operating costs by assisting to comfortably and efficiently manage operations. It raises the level of customer satisfaction and the competitive edge of our products.

## Widescreen monitor

Conveniently customisable and with a choice of 26 languages, the widescreen monitor with simple switches and multifunction keys gives fingertip access to a large range of functions and operating info. The rear camera view and an AdBlue® level gauge are now incorporated into the default main screen.



Quick view on the operation logs



With KomVision, various camera view options are available whilst maintaining constant "birdview" from above the machine



Operator identification function

## Information & communication technology



### Knowledge

You get quick answers to basic and critical questions about your machines – what they're doing, when they did it, where they're located, how they can be used more efficiently and when they need to be serviced. Performance data is relayed by wireless communication technology (satellite, GPRS or 4G depending on model) from the machine to a computer and to the local Komatsu distributor – who's readily available for expert analysis and feedback.

### Convenience

Komtrax enables convenient fleet management on the web, wherever you are. Data is analysed and packaged specifically for effortless and intuitive viewing in maps, lists, graphs and charts. You can foresee eventual maintenance issues and required spare parts, and troubleshoot a problem before Komatsu technicians arrive on site.



### The way to higher productivity

Komtrax uses the latest wireless monitoring technology. Compatible on PC, smartphone or tablet, it delivers insightful and cost saving information about your fleet and equipment, and offers a wealth of information to facilitate peak machine performance. By creating a tightly integrated web of support it allows proactive and preventive maintenance and helps to efficiently run a business.

### Power

The detailed information that Komtrax puts at your fingertips 24 hours a day, 7 days a week gives the power to make better daily and long-term strategic decisions – at no extra cost. Problems can be anticipated, maintenance schedules customised, downtime minimised and machines kept where they belong: working on the jobsite.



## Easy maintenance



### Central service points

Komatsu designed the PC230NHD-11 with centralised and conveniently located service points to make necessary inspections and maintenance quick and easy.

### Komatsu Care

Komatsu Care is a maintenance program that comes as standard with your new Komatsu machine. It covers factory-scheduled maintenance, performed with Komatsu Genuine parts by Komatsu-trained technicians. Depending on your machine's engine, it also offers extended coverage of the Komatsu Diesel Particulate Filter (KDPF) and of the Selective Catalytic Reduction (SCR). Please contact your local Komatsu distributor for terms and conditions.

### Long-life oil filters

The Komatsu Genuine hydraulic oil filter uses high-performance filtering material for long replacement intervals, which significantly reduces maintenance costs.



### AdBlue® tank

For simple access, the AdBlue® tank is installed on the front stairway.

### Flexible warranty

When you purchase Komatsu equipment, you gain access to a broad range of programmes and services that have been designed to help you get the most from your investment. For example, Komatsu's Flexible Warranty Programme provides a range of extended warranty options on the machine and its components. These can be chosen to meet your individual needs and activities. This programme is designed to help reduce total operating costs.

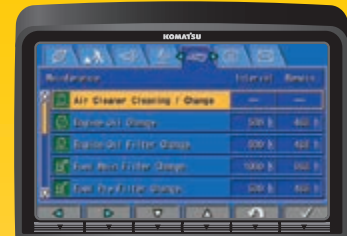

Basic maintenance screen

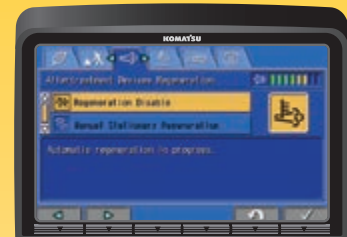

Aftertreatment device regeneration screen for the KDPF



AdBlue® level and refill guidance

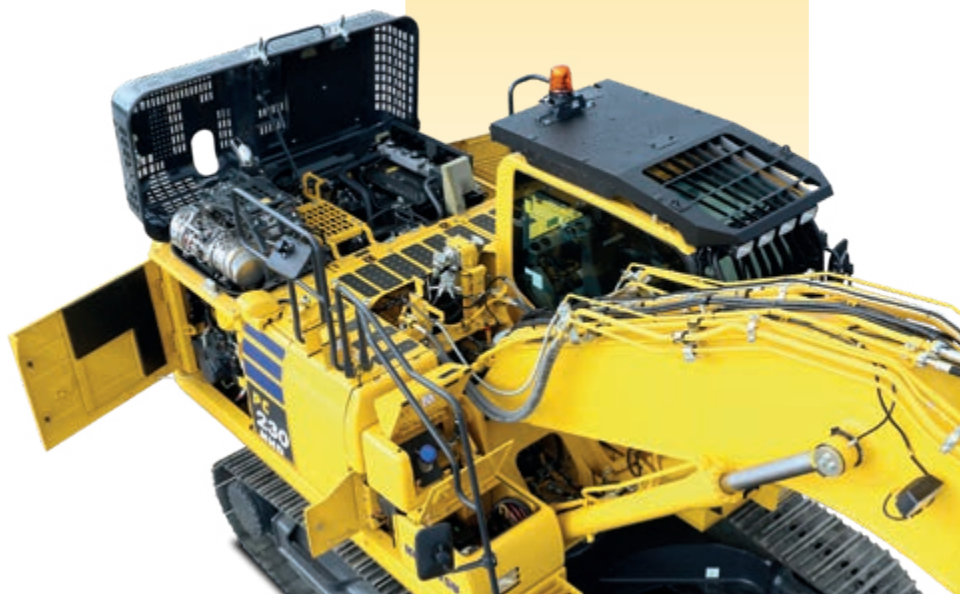

## Quality you can rely on

### Komatsu-quality

With the latest computer techniques and a thorough test programme, Komatsu produces equipment to meet your highest standards. All major components of the PC230NHD-11 are designed and directly manufactured by Komatsu, and essential machine functions are perfectly matched for a highly reliable and productive excavator.

### Rugged design

Maximum toughness and durability are the cornerstones of Komatsu's philosophy – along with safety and top class customer service. Single piece plates and castings are used in key areas of the machine's structure for good load distribution. Highly durable rubbing strips on the underside of the arm protect the structure against impact damage.

### Extensive support network

The extensive Komatsu distribution and dealer network is standing by to help keep your fleet in optimum condition. Customised servicing packages are available, with express availability of spare parts, to make sure that your Komatsu equipment continues to perform at its peak.



Durable and reliable undercarriage design for maximum protection



Cast boom foot and single piece boom plates

# Specifications

## Engine

|                             |   |
|-----------------------------|---|
| Model                       | Komatsu SAA6D107E-3   |
| Type                        | Common rail direct injection, water-cooled, emissionised, turbocharged, after-cooled diesel                               |
| Engine power                |   |
| at rated engine speed       | 2000 rpm  |
| ISO 14396                   | 123 kW / 165 HP   |
| ISO 9249 (net engine power) | 123 kW / 165 HP   |
| No. of cylinders            | 6   |
| Bore × stroke               | 107 × 124 mm  |
| Displacement                | 6.69 l  |
| Air filter type             | Double element type with monitor panel dust indicator and auto dust evacuator   |
| Cooling                     | Suction type cooling fan with radiator fly screen   |
| Fuel                        | Diesel fuel, conforming to EN590 Class 2/Grade D. Paraffinic fuel capability (HVO, GTL, BTL), conforming to EN 15940:2016 |

## Hydraulic system

|                       |   |
|-----------------------|---|
| Type                  | HydrauMind. Closed-centre system with load sensing and pressure compensation valves         |
| Additional circuits   | 2 additional circuits with proportional control can be installed                            |
| Main pump             | 2 variable displacement piston pumps supplying boom, arm, bucket, swing and travel circuits |
| Maximum pump flow     | 475 l/min   |
| Relief valve settings |   |
| Implement             | 380 kg/cm <sup>2</sup>  |
| Travel                | 380 kg/cm <sup>2</sup>  |
| Swing                 | 295 kg/cm <sup>2</sup>  |
| Pilot circuit         | 33 kg/cm <sup>2</sup>   |

## Service refill capacities

|                         |        |
|-------------------------|--------|
| Fuel tank               | 325 l  |
| Radiator                | 30.7 l |
| Engine oil              | 23.1 l |
| Swing drive             | 6.5 l  |
| Hydraulic tank          | 132 l  |
| Final drive (each side) | 5.0 l  |
| AdBlue® tank            | 18.8 l |

## Swing system

|              |   |
|--------------|---|
| Type         | Axial piston motor driving through planetary double reduction gearbox |
| Swing lock   | Electrically actuated wet multidisc brake integrated into swing motor |
| Swing speed  | 0 - 12.4 rpm  |
| Swing torque | 65 kNm  |

## Drives and brakes

|                      |  |
|----------------------|--|
| Steering control     | 2 levers with pedals giving full independent control of each track |
| Drive method         | Hydrostatic  |
| Travel operation     | Automatic 3-speed selection  |
| Gradeability         | 70%, 35°   |
| Max. travel speeds   |  |
| Lo / Mi / Hi         | 3.0 / 4.1 / 5.5 km/h   |
| Maximum drawbar pull | 20600 kg   |
| Brake system         | Hydraulically operated discs in each travel motor                  |

## Undercarriage

|                             |  |
|-----------------------------|--|
| Construction                | X-frame centre section with box section track frames |
| Track assembly              |  |
| Type                        | Fully sealed   |
| Shoes (each side)           | 47   |
| Tension                     | Combined spring and hydraulic unit                   |
| Rollers                     |  |
| Track rollers (each side)   | 8  |
| Carrier rollers (each side) | 2  |

## Environment

|   |   |
|---|---|
| Engine emissions  | Fully complies with EU Stage V exhaust emission regulations     |
| Noise levels  |   |
| LwA external  | 100 dB(A) (2000/14/EC Stage II)                                 |
| LpA operator ear  | 67 dB(A) (ISO 6396 dynamic test)                                |
| Vibration levels (EN 12096:1997)  |   |
| Hand/arm  | ≤ 2.5 m/s <sup>2</sup> (uncertainty K = 0.49 m/s <sup>2</sup> ) |
| Body  | ≤ 0.5 m/s <sup>2</sup> (uncertainty K = 0.24 m/s <sup>2</sup> ) |
| Contains fluorinated greenhouse gas HFC-134a (GWP 1430).<br>Quantity of gas 0.9 kg, CO <sub>2</sub> equivalent 1.29 t |   |

| Operating weight (appr.)       | Mono boom        |                         | Two-piece boom   |                         |
|--------------------------------|------------------|-------------------------|------------------|-------------------------|
|                                | Operating weight | Ground pressure         | Operating weight | Ground pressure         |
| Triple grouser shoes<br>550 mm | 23515 kg         | 0.57 kg/cm <sup>2</sup> | 24315 kg         | 0.59 kg/cm <sup>2</sup> |

Operating weight, including specified work equipment, 2.4 m arm, 650 kg bucket, operator, lubricant, coolant, full fuel tank and the standard equipment.

| Max. bucket capacity and weight            | Mono boom                   |                            | Two-piece boom              |                            |
|--|-----------------------------|----------------------------|-----------------------------|----------------------------|
|  | 2.4 m                       | 2.9 m                      | 2.4 m                       | 2.9 m                      |
| Material weight up to 1.2 t/m <sup>3</sup> | 1.45 m <sup>3</sup> 1050 kg | 1.30 m <sup>3</sup> 975 kg | 1.33 m <sup>3</sup> 1000 kg | 1.21 m <sup>3</sup> 925 kg |
| Material weight up to 1.5 t/m <sup>3</sup> | 1.23 m <sup>3</sup> 950 kg  | 1.10 m <sup>3</sup> 875 kg | 1.13 m <sup>3</sup> 900 kg  | 1.03 m <sup>3</sup> 850 kg |
| Material weight up to 1.8 t/m <sup>3</sup> | 1.00 m <sup>3</sup> 850 kg  | 0.96 m <sup>3</sup> 800 kg | 0.98 m <sup>3</sup> 825 kg  | 0.89 m <sup>3</sup> 775 kg |

Max. capacity and weight have been calculated according to ISO 10567:2007.

Please consult with your distributor for the correct selection of buckets and attachments to suit the application.

#### Bucket and arm force

| Arm length                       | 2.4 m    | 2.9 m    |
|----------------------------------|----------|----------|
| Bucket digging force             | 16500 kg | 14100 kg |
| Bucket digging force at PowerMax | 17500 kg | 15200 kg |
| Arm crowd force                  | 12200 kg | 10300 kg |
| Arm crowd force at PowerMax      | 13000 kg | 11000 kg |

## Dimensions and performance figures

| Machine dimensions                           | PC230NHD-11 |
|--|-------------|
| A Overall width of upper structure           | 2540 mm     |
| B Overall height of cab                      | 3105 mm     |
| C Overall length of basic machine            | 4955 mm     |
| D Tail length                                | 2860 mm     |
| Tail swing radius                            | 2880 mm     |
| E Clearance under counterweight              | 1125 mm     |
| F Machine tail height                        | 2295 mm     |
| F' Machine tail height (top of engine cover) | 2810 mm     |
| G Ground clearance                           | 465 mm      |
| H Tumbler centre distance                    | 3410 mm     |
| I Track length                               | 4305 mm     |
| J Track gauge                                | 1990 mm     |
| K Track shoe width                           | 550 mm      |
| L Overall track width with 550 mm shoes      | 2540 mm     |

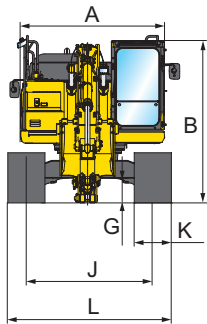

Mono boom

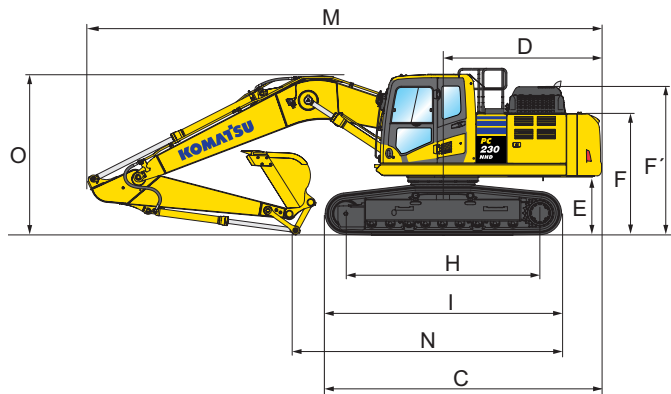

Two-piece boom

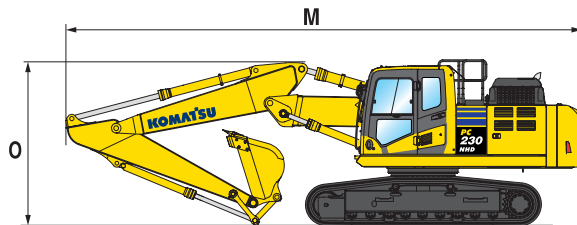

| Transport dimensions              | Mono boom |         | Two-piece boom |         |
|-----------------------------------|-----------|---------|----------------|---------|
| Arm length                        | 2.4 m     | 2.9 m   | 2.4 m          | 2.9 m   |
| M Transport length                | 9630 mm   | 9690 mm | 9495 mm        | 9600 mm |
| N Length on ground (transport)    | 5675 mm   | 4875 mm | 6035 mm        | 5250 mm |
| O Overall height (to top of boom) | 3190 mm   | 3180 mm | 3215 mm        | 3160 mm |



# Working range

## Mono boom

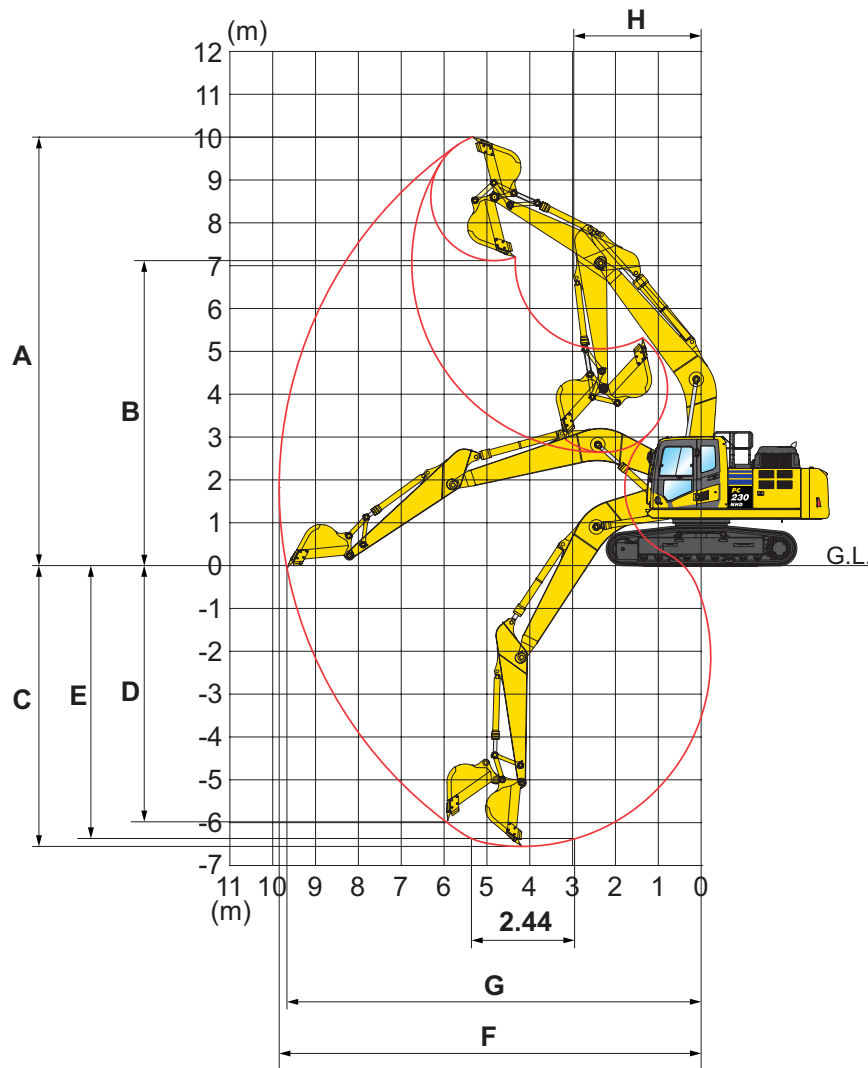

### Working range

| Arm length                                   | 2.4 m   | 2.9 m    |
|--|---------|----------|
| A Max. digging height                        | 9765 mm | 10095 mm |
| B Max. dumping height                        | 6895 mm | 7215 mm  |
| C Max. digging depth                         | 5955 mm | 6465 mm  |
| D Max. vertical wall digging depth           | 5365 mm | 5885 mm  |
| E Max. digging depth of cut for 2.44 m level | 5730 mm | 6280 mm  |
| F Max. digging reach                         | 9355 mm | 9850 mm  |
| G Max. digging reach at ground level         | 9160 mm | 9655 mm  |
| H Min. swing radius                          | 3065 mm | 2975 mm  |
| Max. height at min. swing radius             | 8155 mm | 8110 mm  |

Two-piece boom

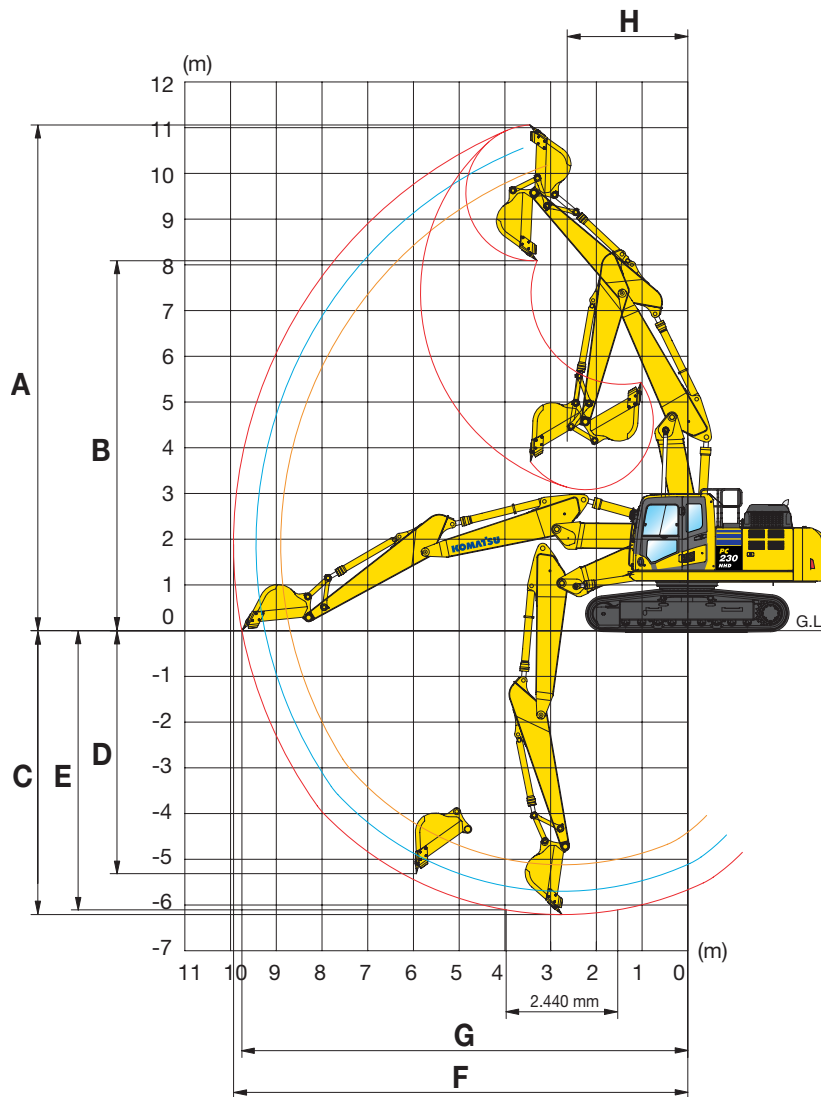

Working range

| Arm length                                   | 2.4 m    | 2.9 m    |
|--|----------|----------|
| A Max. digging height                        | 10630 mm | 11085 mm |
| B Max. dumping height                        | 7665 mm  | 8115 mm  |
| C Max. digging depth                         | 5670 mm  | 6185 mm  |
| D Max. vertical wall digging depth           | 4710 mm  | 5225 mm  |
| E Max. digging depth of cut for 2.44 m level | 5575 mm  | 6080 mm  |
| F Max. digging reach                         | 9415 mm  | 9935 mm  |
| G Max. digging reach at ground level         | 9221 mm  | 9750 mm  |
| H Min. swing radius                          | 2830 mm  | 2640 mm  |
| Max. height at min. swing radius             | 8402 mm  | 8390 mm  |



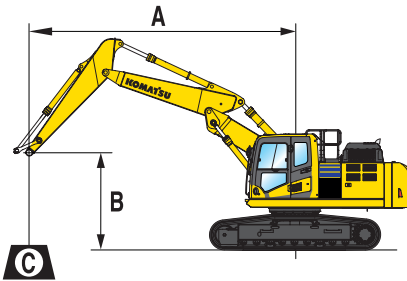



**A** – Reach from swing center

**B** – Bucket hook height

**C** – Lifting capacities

 – Rating over front

 – Rating over side

 – Rating at maximum reach

Weights:

With 2.4 m arm: bucket linkage













and bucket cylinder: 359 kg

With 2.9 m arm: bucket linkage

and bucket cylinder: 335 kg

## Two-piece boom

With 550 mm shoes

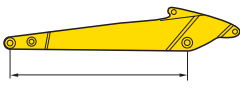
| Arm length   | <b>A</b> |  |   |  | 7.5 m  |  | 6.0 m  |  | 4.5 m   |  | 3.0 m  |  | 1.5 m  |  |
|--|----------|--|--|--|--|--|--|--|---|--|--|--|--|--|
|  | <b>B</b> |  |  |  |  |  |  |  |  |  |  |  |  |  |
| <br>2.4 m | 7.5 m    | kg   | *5800  | 5400   |  |  |  |  |   | *7800  | 7750   |  |  |  |
|  | 6.0 m    | kg   | *5350  | 3950   |  |  | *6350  | 4850   | *8000   | 7600   |  |  |  |  |
|  | 4.5 m    | kg   | *5250  | 3300   |  |  | *6700  | 4650   | *9100   | 7150   |  |  |  |  |
|  | 3.0 m    | kg   | 5100   | 3000   | 5450   | 3200   | *7350  | 4400   | *11450  | 6550   |  |  |  |  |
|  | 1.5 m    | kg   | 4950   | 2900   | 5350   | 3100   | 7400   | 4200   | 11400   | 6100   |  |  |  |  |
|  | 0.0 m    | kg   | 5100   | 2950   | 5300   | 3050   | 7250   | 4050   | 11200   | 5900   |  |  |  |  |
|  | -1.5 m   | kg   | 5650   | 3250   |  |  | 7200   | 4000   | 11150   | 5850   | *12350   | 10850  |  |  |
| -3.0 m   | kg       |  |  |  |  |  |  |  |   |  |  |  |  |  |

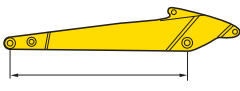
|  |        |    |       |       |       |      |       |       |       |       |        |        |
|--|--------|----|-------|-------|-------|------|-------|-------|-------|-------|--------|--------|
| <br>2.9 m | 7.5 m  | kg | *3600 | *3600 |       |      | *4500 | *4500 | *6400 | *6400 |        |        |
|  | 6.0 m  | kg | *3300 | *3300 |       |      | *5750 | 4700  | *6850 | *6850 |        |        |
|  | 4.5 m  | kg | *3200 | 2800  | *4850 | 3100 | *6000 | 4450  | *8050 | 7000  | *11150 | *11150 |
|  | 3.0 m  | kg | 3250  | 2500  | *5000 | 2950 | 6600  | 4150  | *9900 | 6300  |        |        |
|  | 1.5 m  | kg | 3450  | 2400  | 5050  | 2800 | 7050  | 3850  | 11050 | 5750  |        |        |
|  | 0.0 m  | kg | 3800  | 2450  | 4950  | 2700 | 6850  | 3650  | 10700 | 5450  | *7250  | *7250  |
|  | -1.5 m | kg | 4450  | 2650  | 4950  | 2700 | 6750  | 3600  | 10600 | 5350  | *11850 | 10100  |
| -3.0 m   | kg     |    |       |       |       |      |       |       |       |       |        |        |

\* Load is limited by hydraulic capacity rather than tipping. Ratings are based on SAE Standard No. J1097.

Rated loads do not exceed 87% of hydraulic lift capacity or 75% of tipping load.

When lifting with additional equipment installed to the arm, please subtract the weight of all additional equipment from the values stated.

## Standard and optional equipment

### Engine

|   |   |
|---|---|
| Komatsu SAA6D107E-3 turbocharged common rail direct injection diesel engine | ● |
| EU Stage V compliant  | ● |
| Suction type cooling fan with radiator fly screen                           | ● |
| Automatic engine warm-up system   | ● |
| Engine overheat prevention system   | ● |
| Fuel control dial   | ● |
| Auto-deceleration function  | ● |
| Adjustable idle shutdown  | ● |
| Engine key stop   | ● |
| Engine ignition can be password secured on request                          | ● |
| Alternator 24 V / 90 A  | ● |
| Starter motor 24 V / 5.5 kW   | ● |
| Batteries 2 × 12 V / 180 Ah   | ● |

### Hydraulic system

|  |   |
|--|---|
| Electronic closed-centre load sensing (E-CLSS) hydraulic system (HydraMind)  | ● |
| Pump and engine mutual control (PEMC) system   | ● |
| 6-working mode selection system; Power mode, Economy mode, Breaker mode, Attachment Power and Attachment Economy mode, and Lifting/Fine Operation mode | ● |
| PowerMax function  | ● |
| PPC wrist control levers for arm, boom, bucket and swing, with sliding proportional control for attachments and 3 auxiliary buttons                    | ● |
| Prepared for hydraulic quick-coupler   | ● |
| Additional hydraulic functions   | ○ |
| Komatsu Integrated Attachment Control (KIAC)   | ○ |

### Undercarriage

|                                 |   |
|---------------------------------|---|
| Track roller guards             | ● |
| Track frame under-guards        | ● |
| 550 mm triple grouser shoes     | ● |
| Full length track roller guards | ○ |

### Drives and brakes

|   |   |
|---|---|
| Hydrostatic, 3-speed travel system with automatic shift and planetary gear type final drives, and hydraulic travel and parking brakes | ● |
| PPC control levers and pedals for steering and travel   | ● |

### Cabin

|   |   |
|---|---|
| Reinforced safety SpaceCab™; highly pressurised and tightly sealed hyper viscous mounted cab with tinted safety glass windows, large roof window with sun shade, pull-up type front window with locking device, removable lower window, front window wiper with intermittent feature, sun roller blind, cigarette lighter, ashtray, luggage shelf, std. floor mat, additional floor mat | ● |
| Heated, high-back air-suspended seat with lumbar support, console mounted height adjustable arm rests, and retractable seat belt  | ● |
| Automatic climate control system  | ● |
| 12 / 24 Volt power supplies   | ● |
| USB-A / USB-C power supplies  | ● |
| Utility bar   | ● |
| Beverage holder and magazine rack   | ● |
| Hot and cool box  | ● |
| DAB+ radio with Bluetooth®, USB, AUX and hands-free kit   | ● |
| Premium comfort seat  | ○ |
| Lower wiper   | ○ |
| Rain visor (not with OPG)   | ○ |

### Service and maintenance

|  |   |
|--|---|
| Automatic fuel line de-aeration  | ● |
| Double element type air cleaner with dust indicator and auto dust evacuator  | ● |
| Komtrax – Komatsu wireless monitoring system (4G)  | ● |
| Komatsu Care – a maintenance program for Komatsu customers   | ● |
| Multifunction video compatible colour monitor with Equipment Management and Monitoring System (EMMS) and efficiency guidance | ● |
| Toolkit  | ● |
| Service points   | ○ |
| Automatic greasing system  | ○ |

### LED lighting system

|  |   |
|--|---|
| Working lights: 2 revolving frame, 1 boom (l.h.)   | ● |
| Coming home light function   | ● |
| Additional working lights (#1): 2 cab roof (front), 1 cab roof (rear), 1 boom (r.h.), 1 counterweight, beacon  | ○ |
| Additional working lights (#2): 4 cab roof (front), 1 cab roof (rear), 1 boom (r.h.), 1 counterweight, 2 boom cylinders, 2 revolving frame (l.h. + r.h.), beacon | ○ |

## Safety equipment

|  |   |
|--|---|
| KomVision surround view system                       | ● |
| Electric horn  | ● |
| Overload warning device                              | ● |
| Audible travel alarm                                 | ● |
| Boom safety valves                                   | ● |
| Large handrails                                      | ● |
| Rear-view mirrors (for cab adjustable without tools) | ● |
| Battery main switch                                  | ● |
| ROPS compliant to ISO 12117-2:2008                   | ● |
| Emergency engine stop switch                         | ● |
| Seat belt caution indicator                          | ● |
| Neutral position detection system                    | ● |
| Arm safety valve                                     | ● |
| OPG Level II front guard (FOPS), hinged type         | ○ |
| OPG Level II top guard (FOPS)                        | ○ |

## Work equipment

|                                 |   |
|---------------------------------|---|
| Mono boom                       | ○ |
| Two-piece boom                  | ○ |
| Bucket linkage with lifting eye | ○ |
| 2.4 m; 2.9 m arms               | ○ |
| Komatsu buckets                 | ○ |
| Komatsu breakers                | ○ |

## Other equipment

|   |   |
|---|---|
| Standard counterweight                                    | ● |
| Remote greasing for swing circle and pins                 | ● |
| Electric refuelling pump with automatic shut-off function | ● |
| Biodegradable oil for hydraulic system                    | ○ |
| Customised paint  | ○ |

Further equipment on request

- standard equipment
- optional equipment



A wide range of buckets and attachments is available. Your Komatsu distributor is ready to assist you with the selection of suitable options.

This specification sheet may contain attachments and optional equipment that are not available in your area. Please consult your local Komatsu distributor for those items you may require. Materials and specifications are subject to change without notice.

---

Your Komatsu partner:

**KOMATSU**

[komatsu.eu](https://www.komatsu.eu)

